

---

# KANAL TİPİ VANTİLATÖRLER



**İNCİRCİOĐLU**  
VANTİLATÖR, KLİMA İMALAT SAN. VE TİC. LTD. ŐTİ.

---

## KTP SERİSİ EBAT TABLOSU

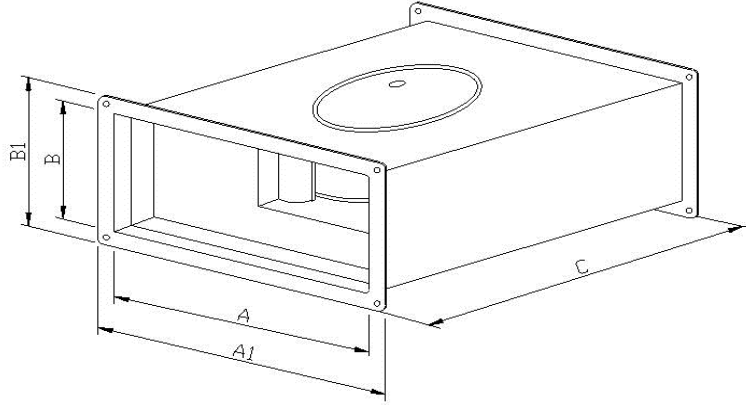

Tip	A mm.	A1 mm.	B mm.	B1 mm.	C mm.
KTPP 133 E	250	310	150	210	350
KTPP 175 E	300	360	150	210	375
KTPP 190 Z	350	410	160	220	440
KTPP 225 E	400	460	200	260	502
KTPP 250 Z	450	510	250	310	502
KTPM 280 E	500	580	300	380	600
KTPP 310 Z	500	580	300	380	600
KTPP 350 E	550	630	350	430	717
KTPP 350 Z	550	630	350	430	717
KTPM 400 E	650	730	400	480	717
KTPP 400 Z	650	730	400	480	717
KTPP 450 Z	750	830	500	580	800
KTPM 450 E	750	830	500	580	800
KTPP 500 Z	800		500		912
KTPM 560 E	1000		550		1200
KTPM 630 E	1100		650		1300

## KTP SERİSİ VERİ TABLOSU

TİP	FİRMA	KODU	ROTOR ÇAPİ	MAX. DEBİ (m <sup>3</sup> /h)	MAX. BASINÇ (Pa)	VOLTAJ (V)	GİRİŞ GÜCÜ (W)	DEVİR (min-1)	AKIM (A)	SICAKLIK (°C)	SES SEVİYESİ (dBA)
KTPP 133 E	EBMPAPST	R2E133-BH66-05	Ø 133	290	170	230	24	2800	0,11	45	56
KTPP 175 E	EBMPAPST	R2E 175-AR72-05	Ø 175	490	250	230	50	2650	0,25	50	63
KTPP 190 Z	ZIEHLABEGG	RH19V-2EP.W6.1R	Ø 192	590	320	230	58	2500	0,26	60	62
KTPP 225 E	EBMPAPST	R2E 225-BD92-09	Ø 225	1200	540	230	135	2650	0,60	60	69
KTPP 250 Z	ZIEHLABEGG	RH25V-2EP.WD.1R	Ø 250	1500	550	230	200	2420	0,86	60	67
KTPM 280 E	EBMPAPST	R2E 280-AE52-05	Ø 280	2110	730	230	225	2700	1,00	40	76
KTPP 310 Z	ZIEHLABEGG	RH31M-2EK.3F.2R	Ø 317	2750	850	230	630	2380	2,80	40	80
KTPP 350 E	EBMPAPST	R4E 355-AF05-05	Ø 360	2365	340	230	170	1410	0,78	55	66
KTPP 350 Z	ZIEHLABEGG	RH35V-4EK.4C.1R	Ø 373	3000	350	230	270	1390	1,30	60	61
KTPM 400 E	EBMPAPST	R4E 400-AB23-05	Ø 404	3150	490	230	270	1300	1,20	45	68
KTPP 400 Z	ZIEHLABEGG	RH40V-4EK.41.1R	Ø 419	4250	420	230	490	1340	2,50	60	64
KTPP 450 Z	ZIEHLABEGG	RH45V-4EK.41.1R	Ø 470	5300	490	230	620	1230	2,80	60	66
KTPM 450 E	EBMPAPST	R4E 450-AK01-01	Ø 485	5900	570	230	680	1250	3,00	70	60
KTPP 500 Z	ZIEHLABEGG	RH50V-4EK.6K.1R	Ø 521	8500	670	230	1300	1340	5,80	60	71
KTPM 560 E	EBMPAPST	R4D 560-AQ03-01	Ø 565	11900	850	230/400	2380	1365	8,65/5,00	40/60	81
KTPM 630 E	EBMPAPST	R4D 630-AQ03-01	Ø 635	18000	1150	230/400	4250	1300	13,10/7,55	40/60	82

**KTP SERİSİ PERFORMANS BİLGİLERİ**

**KTP 133**

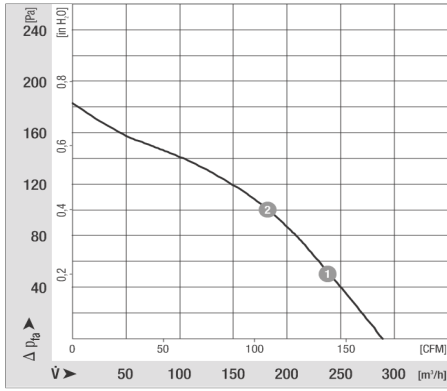

**KTP 175**

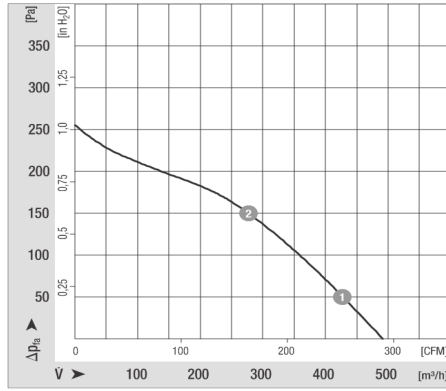

**KTP 190**

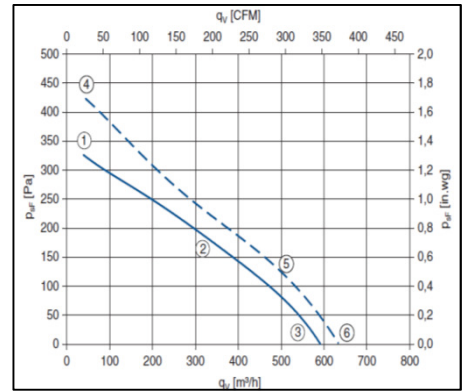

**KTP 225**

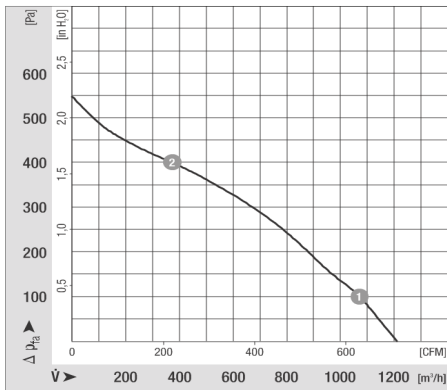

**KTP 250**

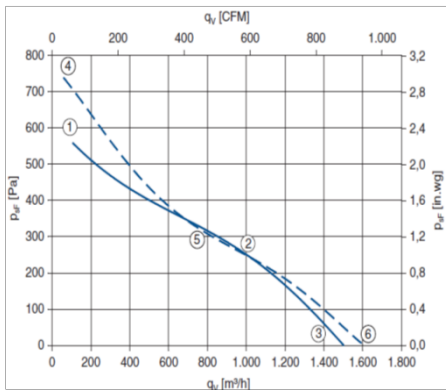

**KTP 280**

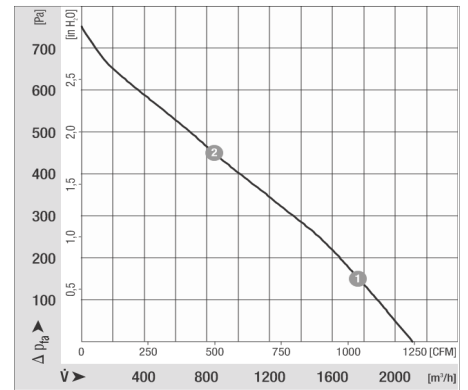

**KTP 310**

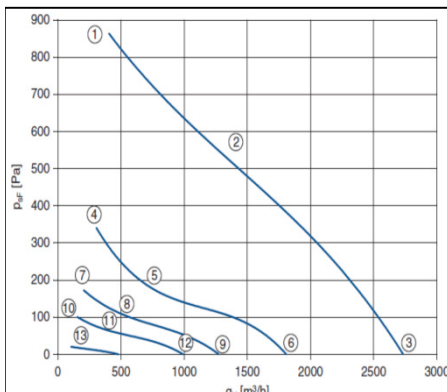

**KTP 350**

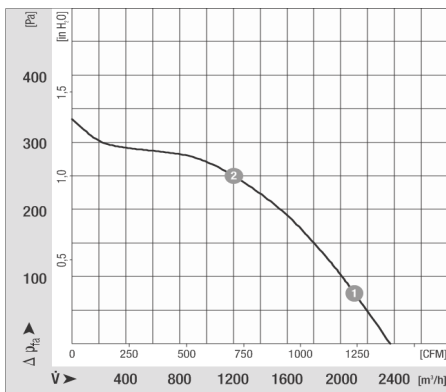

**KTP 350 Z**

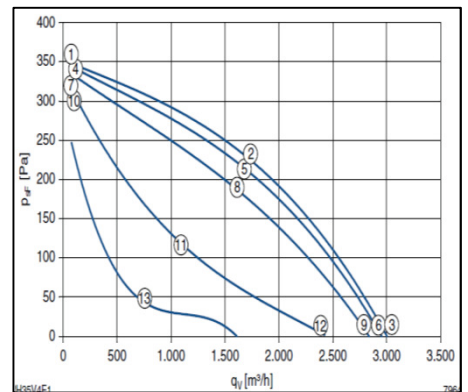

**KTP 400**

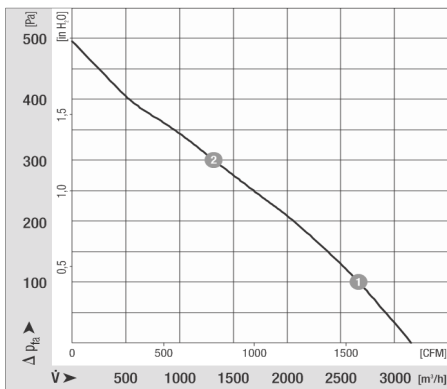

**KTP 400 Z**

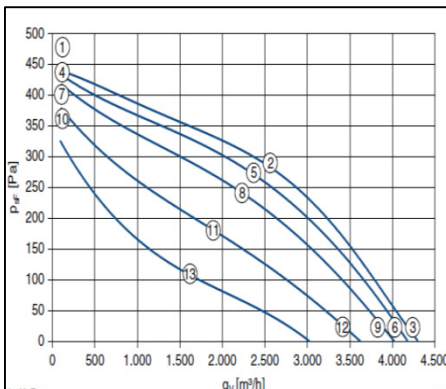

**KTP 450 Z**

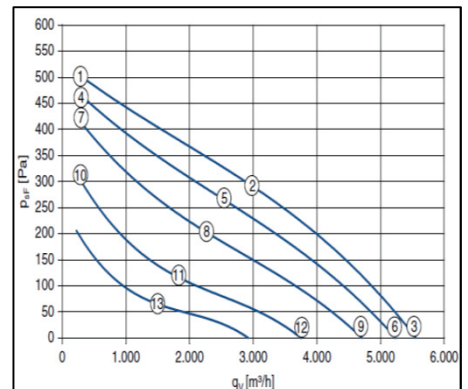

**KTP SERİSİ PERFORMANS BİLGİLERİ**

**KTP 450**

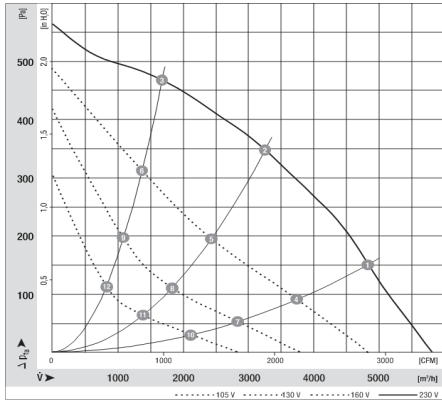

**KTP 500**

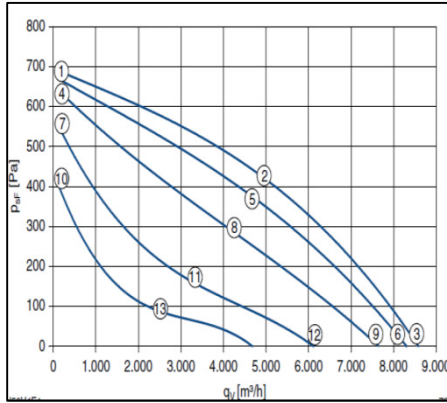

**KTP 560**

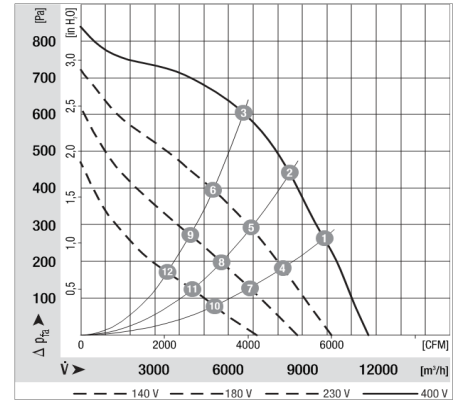

**KTP 630**

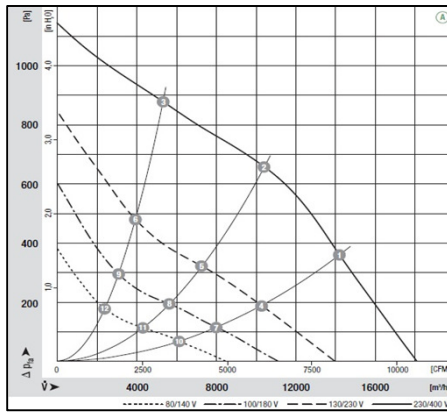

**INCİRCİOĞLU**  
VANTİLATÖR, KLİMA İMALAT SAN. VE TİC. LTD. ŞTİ.

Merkez :

Çobançeşme Mahallesi, Sanayi Caddesi

Genç Osman Sokak, No.16

Yenibosna / İstanbul / Türkiye

☎ : ( 0212 ) 551 1112

Fax : ( 0212 ) 654 2776

Fabrika :

Aşağı Sevindikli Köy Yolu Üzeri

Muratlı / Tekirdağ / Türkiye

☎ : ( 0282 ) 373 7088

Fax : ( 0282 ) 373 7087

[www.incircioglu.com](http://www.incircioglu.com)

[info@incircioglu.com](mailto:info@incircioglu.com)

