

DUCT TYPE VENTILATORS

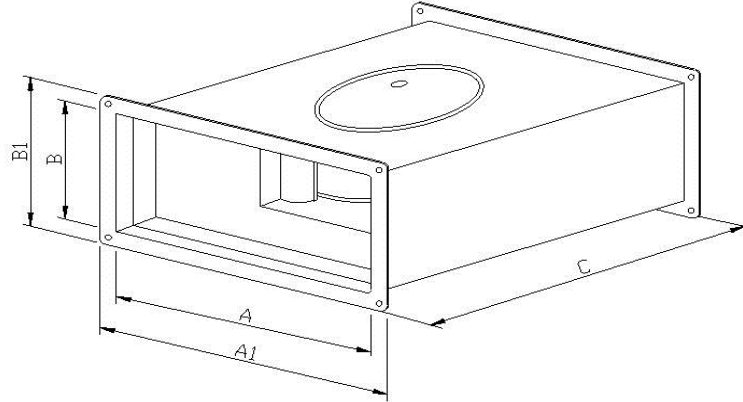

İNCİRCİOĞLU
VANTİLATÖR, KLİMA İMALAT SAN. VE TİC. LTD. ŞTİ.

KTP SERIES DIMENSION TABLE



Type	A mm.	A1 mm.	B mm.	B1 mm.	C mm.
KTPP 133 E	250	310	150	210	350
KTPP 175 E	300	360	150	210	375
KTPP 190 Z	350	410	160	220	440
KTPP 225 E	400	460	200	260	502
KTPP 250 Z	450	510	250	310	502
KTPM 280 E	500	580	300	380	600
KTPP 310 Z	500	580	300	380	600
KTPP 350 E	550	630	350	430	717
KTPP 350 Z	550	630	350	430	717
KTPM 400 E	650	730	400	480	717
KTPP 400 Z	650	730	400	480	717
KTPP 450 Z	750	830	500	580	800
KTPM 450 E	750	830	500	580	800
KTPP 500 Z	800		500		912
KTPM 560 E	1000		550		1200
KTPM 630 E	1100		650		1300

KTP SERIES DATA TABLE

TYPE	IMPELLER DIA.	Max. Airflow (m ³ /h)	Max. Pressure (Pa)	VOLT (V)	Input Power (W)	RPM (min-1)	Current (A)	Temp. (°C)	SOUND LEVEL (dBA)
KTPP 133 E	∅ 133	290	170	230	24	2800	0,11	45	56,00
KTPP 175 E	∅ 175	490	250	230	50	2650	0,25	50	63,00
KTPP 190 Z	∅ 192	590	320	230	58	2500	0,26	60	62,00
KTPP 225 E	∅ 225	1200	540	230	135	2650	0,6	60	69,00
KTPP 250 Z	∅ 250	1500	550	230	200	2420	0,86	60	67,00
KTPM 280 E	∅ 280	2110	730	230	225	2700	1	40	76,00
KTPP 310 Z	∅ 317	2750	850	230	630	2380	2,8	40	80,00
KTPP 350 E	∅ 360	2365	340	230	170	1410	0,78	55	66,00
KTPP 350 Z	∅ 373	3000	350	230	270	1390	1,3	60	61,00
KTPM 400 E	∅ 404	3150	490	230	270	1300	1,2	45	68,00
KTPP 400 Z	∅ 419	4250	420	230	490	1340	2,5	60	64,00
KTPP 450 Z	∅ 470	5300	490	230	620	1230	2,8	60	66,00
KTPM 450 E	∅ 485	5900	570	230	680	1250	3	70	60,00
KTPP 500 Z	∅ 521	8500	670	230	1300	1340	5,8	60	71,00
KTPM 560 E	∅ 565	11900	850	230/400	2380	1365	8,65/5,00	40/60	81,00
KTPM 630 E	∅ 635	18000	1150	230/400	4250	1300	13,10/7,55	40/60	82,00

KTP SERIES PERFORMANCE DATA

KTP 133

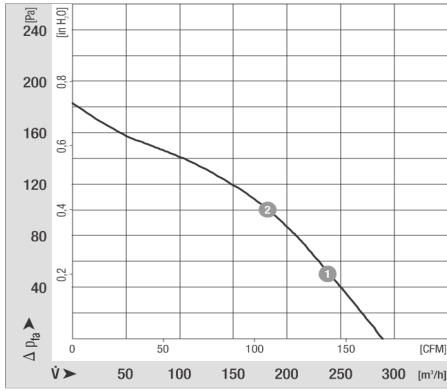

KTP 175

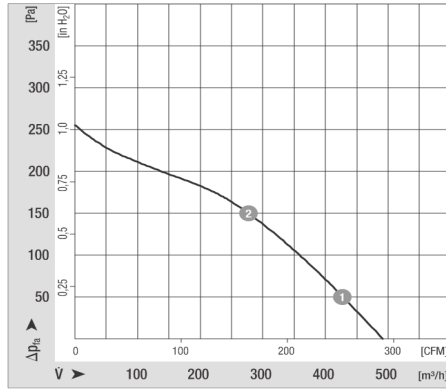

KTP 190

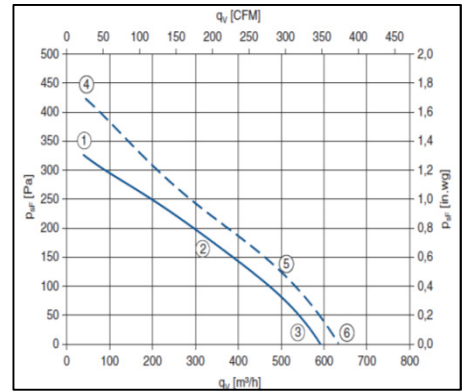

KTP 225

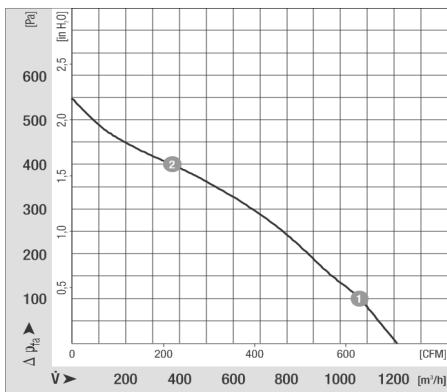

KTP 250

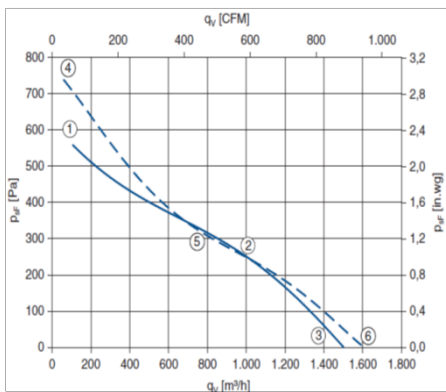

KTP 280

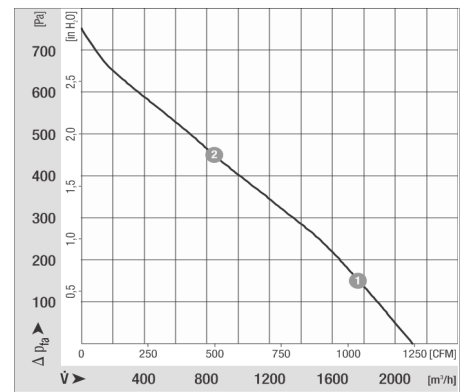

KTP 310

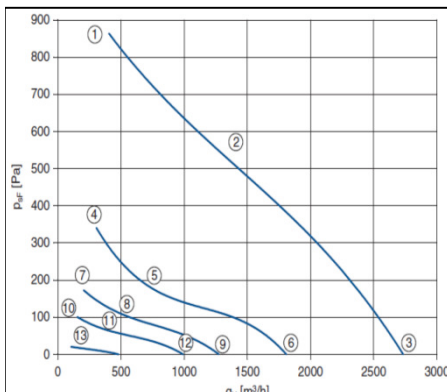

KTP 350

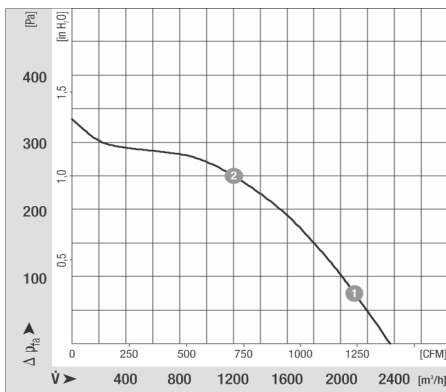

KTP 350 Z

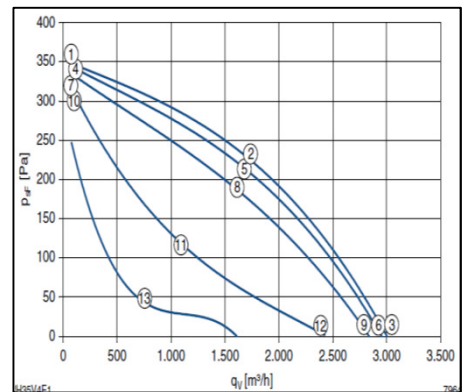

KTP 400

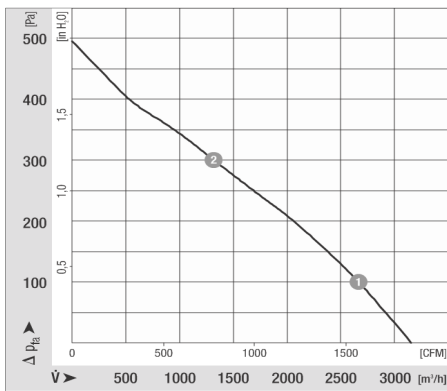

KTP 400 Z

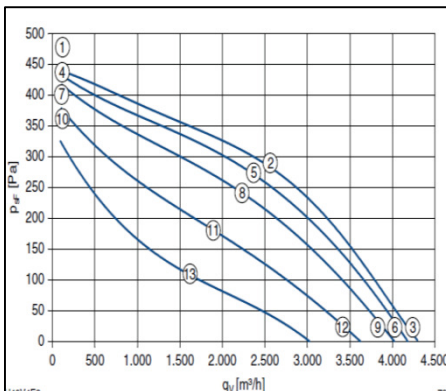

KTP 450 Z

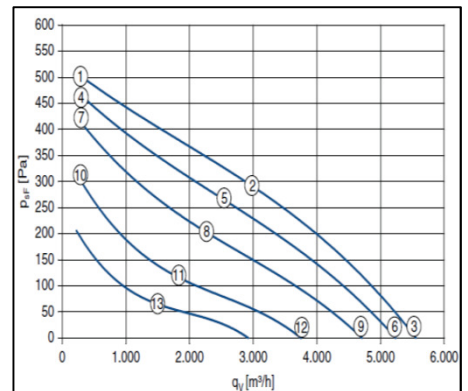

KTP SERIES PERFORMANCE DATA

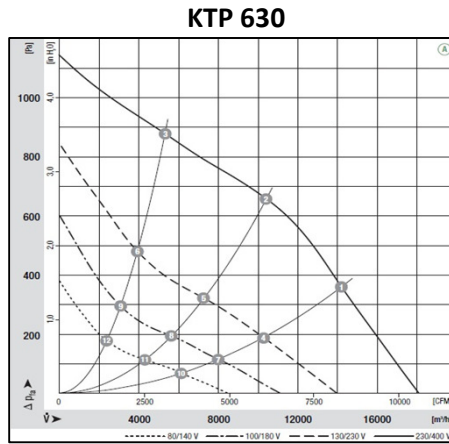
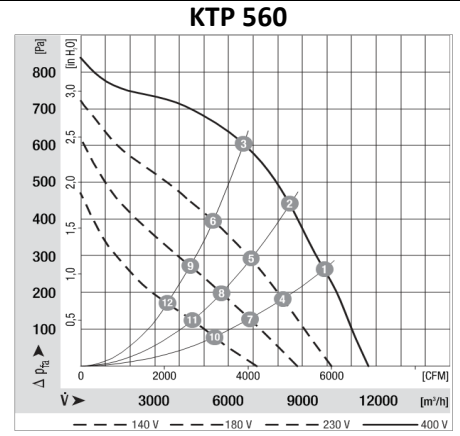
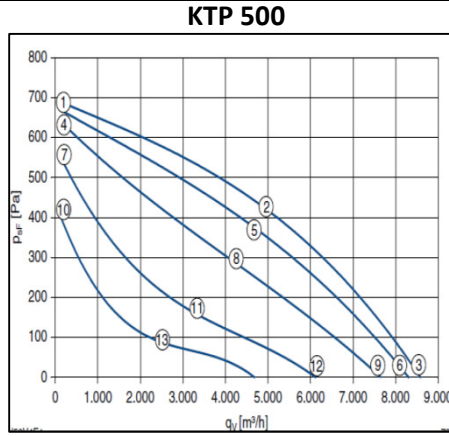
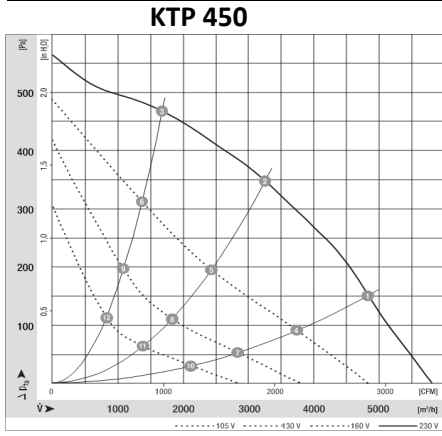

INCİRCİOĞLU
VANTİLATÖR, KLİMA İMALAT SAN. VE TİC. LTD. ŞTİ.

Head Office : Çobançeşme Mahallesi, Sanayi Caddesi
Genç Osman Sokak, No.16
Yenibosna / İstanbul / Türkiye
☎ : (0212) 551 1112
Fax : (0212) 654 2776

Factory : Aşağı Sevindikli Köy Yolu Üzeri
Muratlı / Tekirdağ / Türkiye
☎ : (0282) 373 7088
Fax : (0282) 373 7087

www.incircioglu.com
info@incircioglu.com



ISO 9001:2008

